

CABINE INTEGRALE SODA

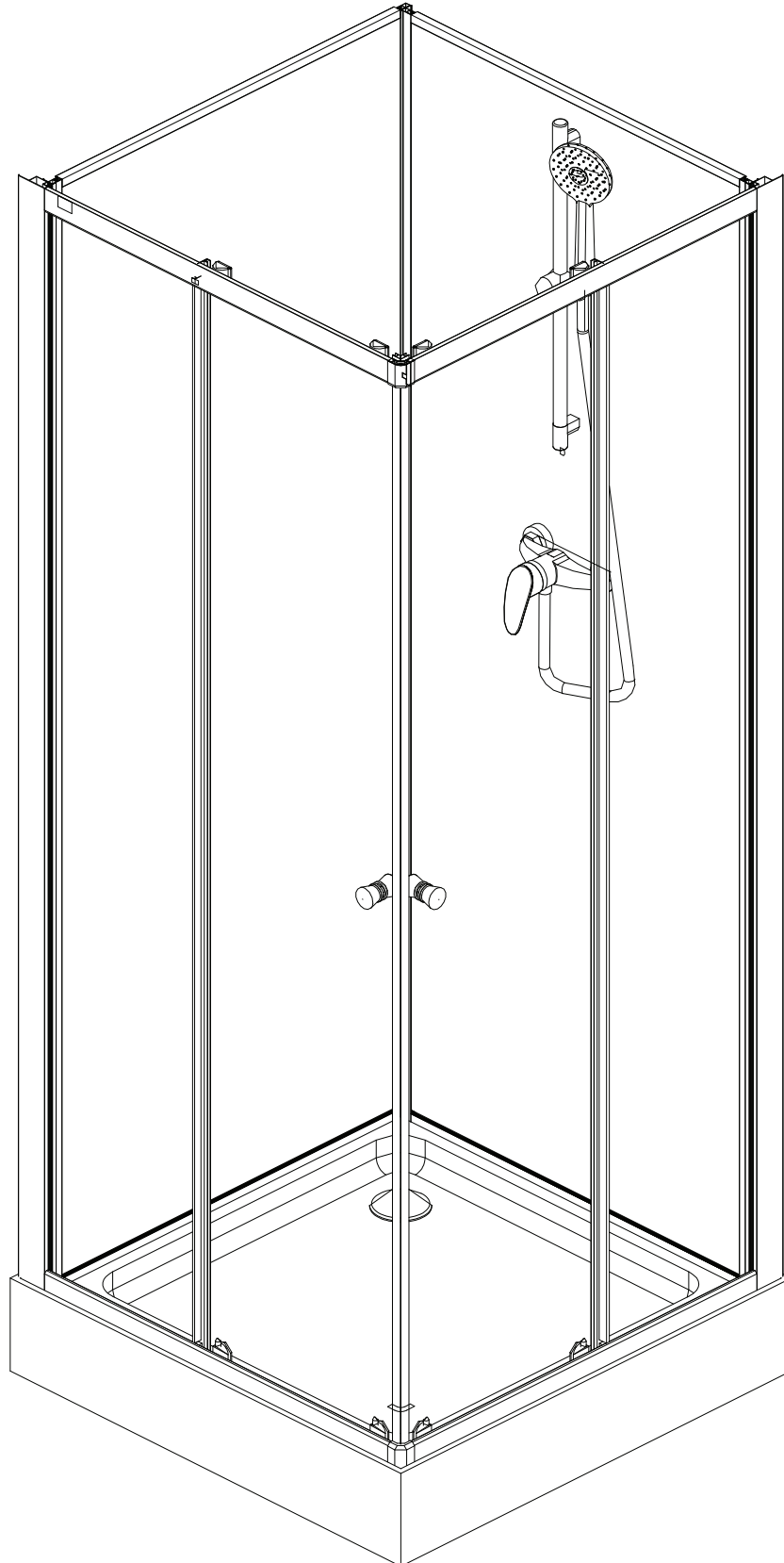

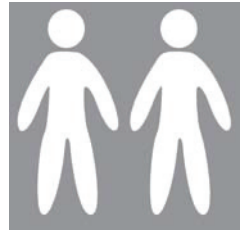

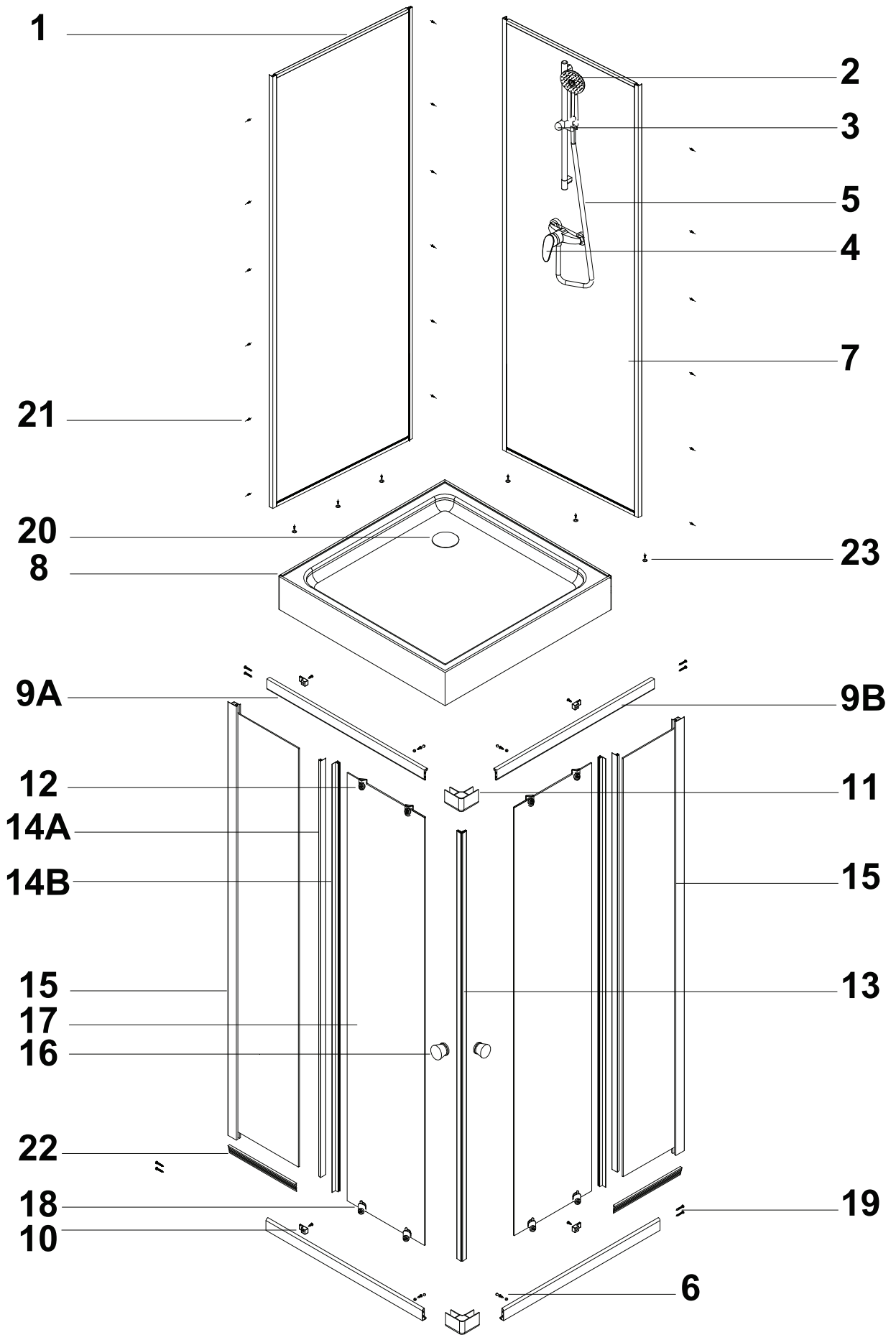



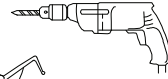
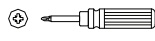
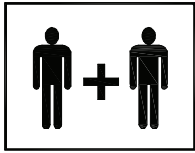

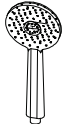

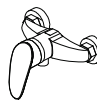
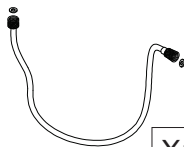

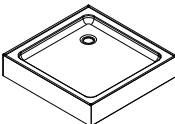
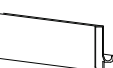
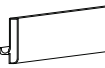

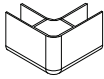

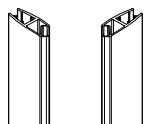
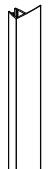
80X80 H.220

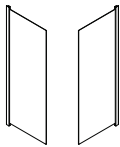
Réf : 1248649





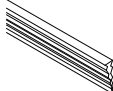

1  X1	2  X1	3  X1	4  X1	5  X1
6  ST3.9X12 X4	7  X1	8  X1	9A  X2	9B  X2
10  ST3.9X10 X4	11  X2	12  X4	13  X1	14A  X2
14B  X2	15  X1	16  X2	17  X2	18  X4
19  ST3.9X50 X8	20  X1	21  ST3.9X10 X18	22  X2	23  ST3.9X16 X6

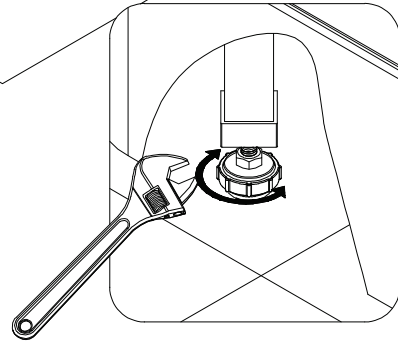
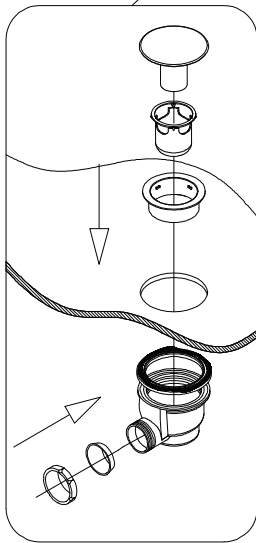
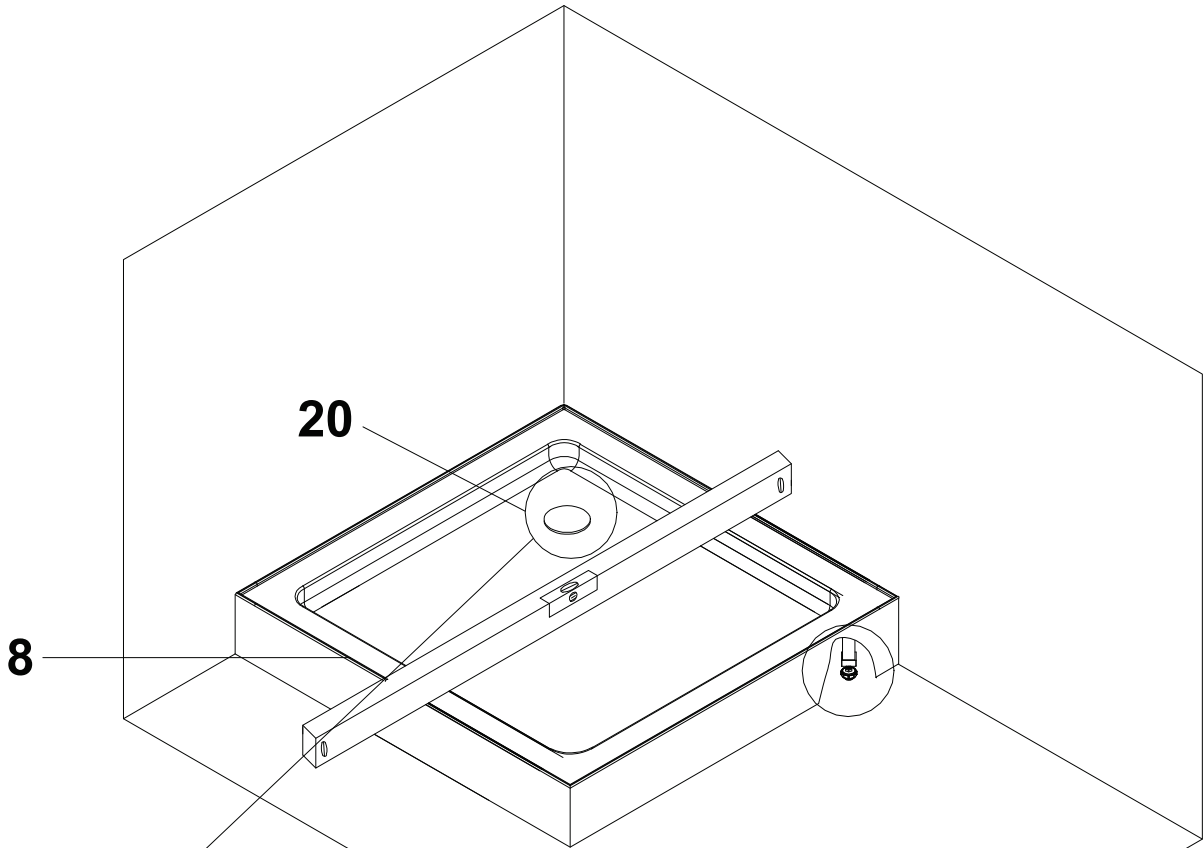
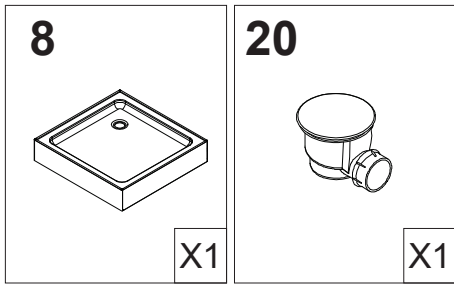

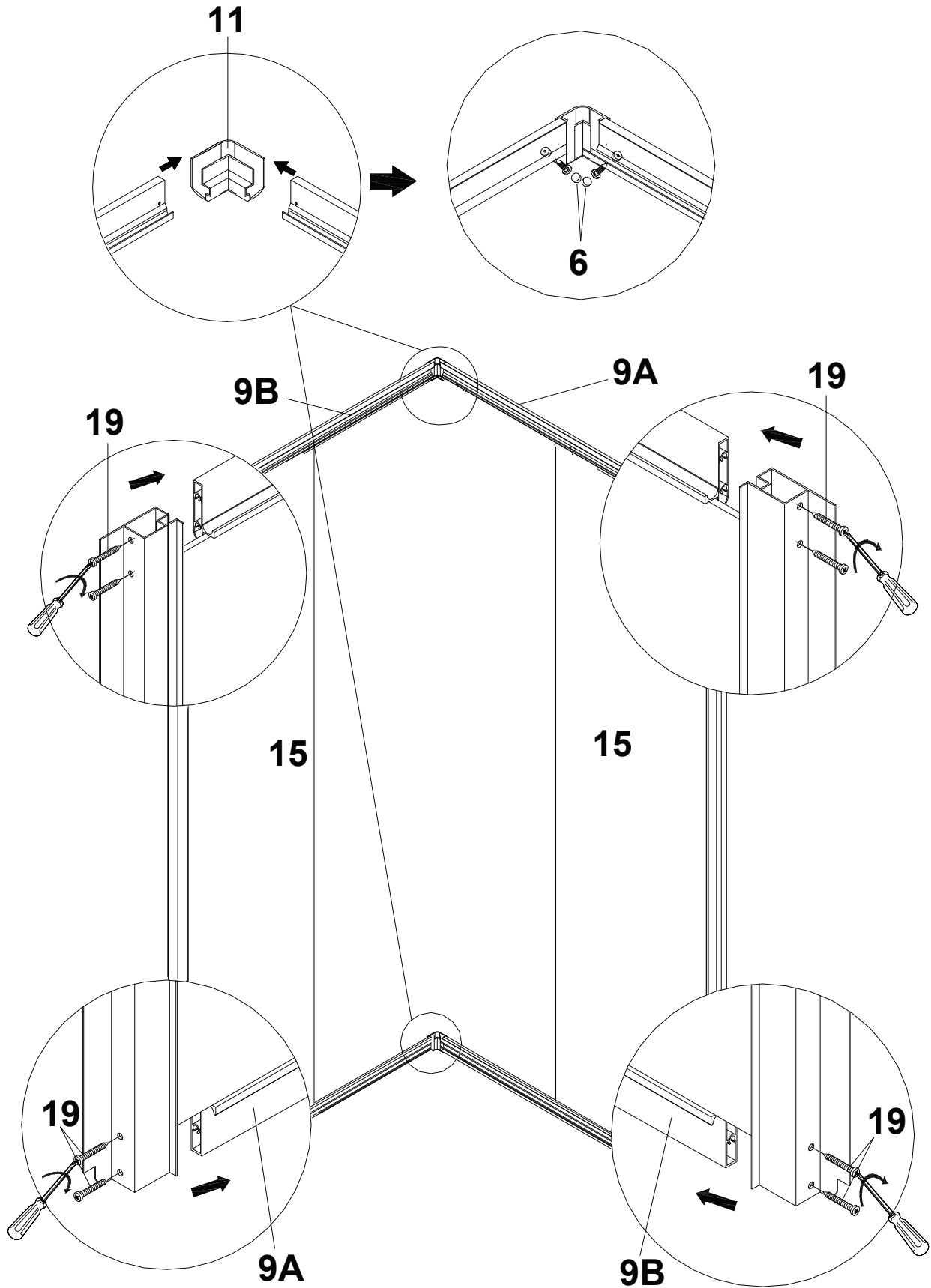
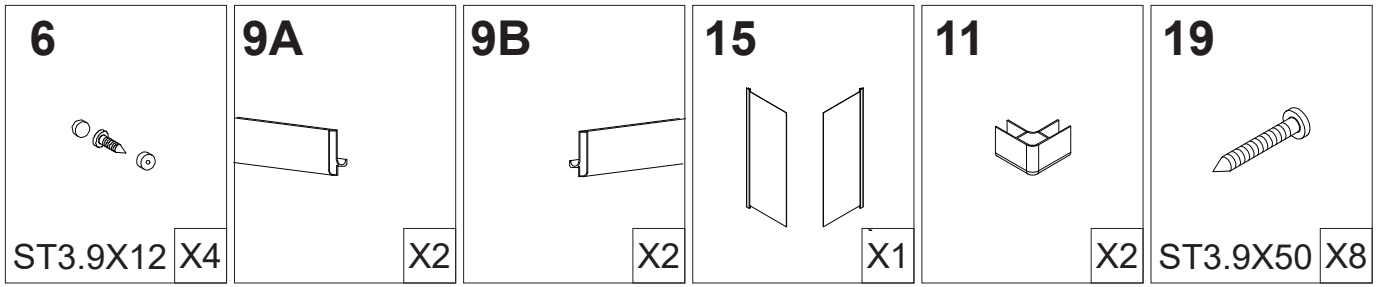

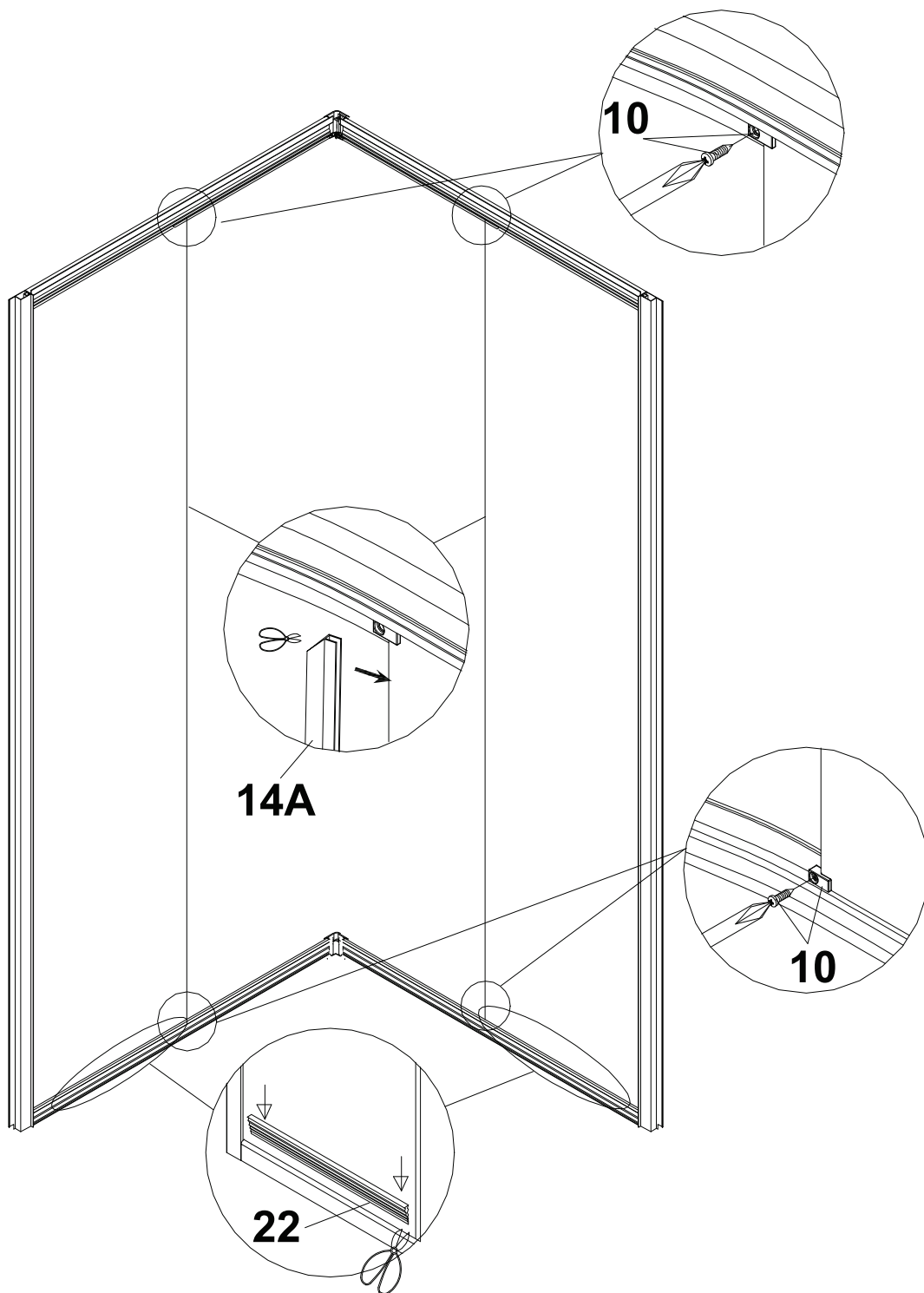
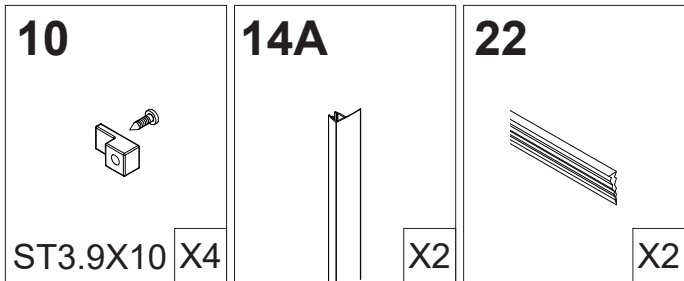

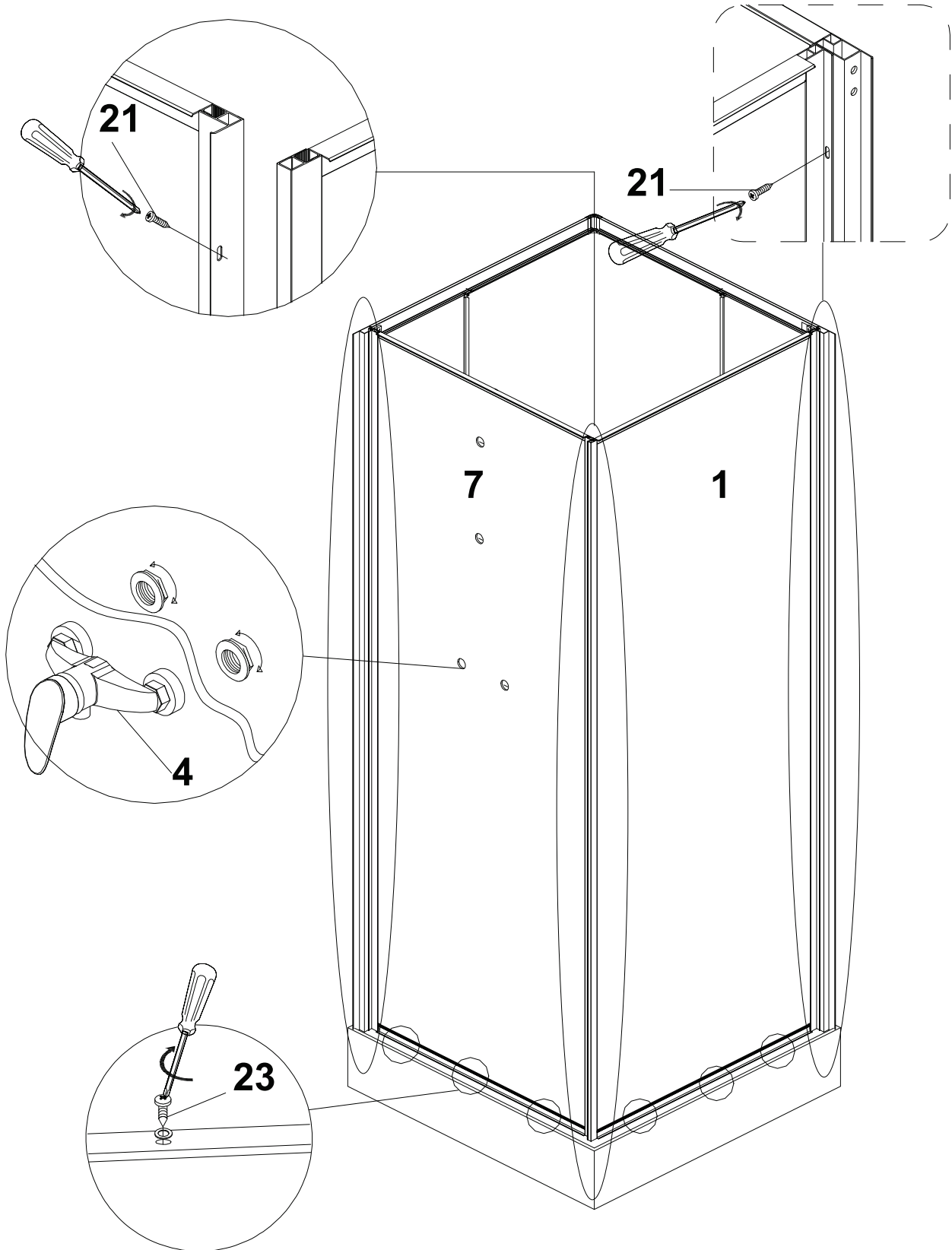
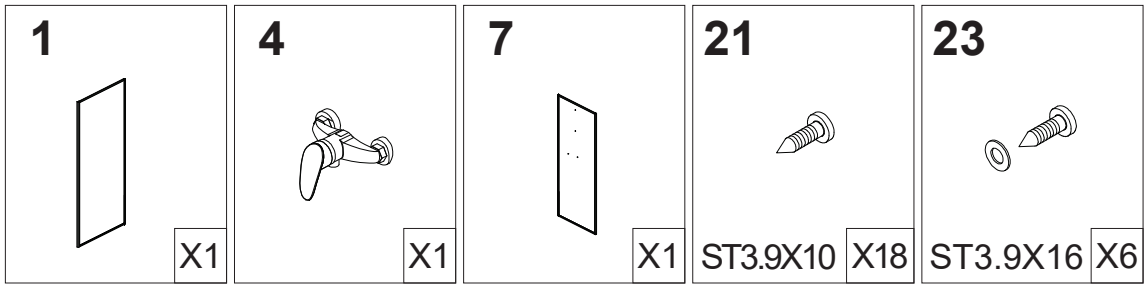

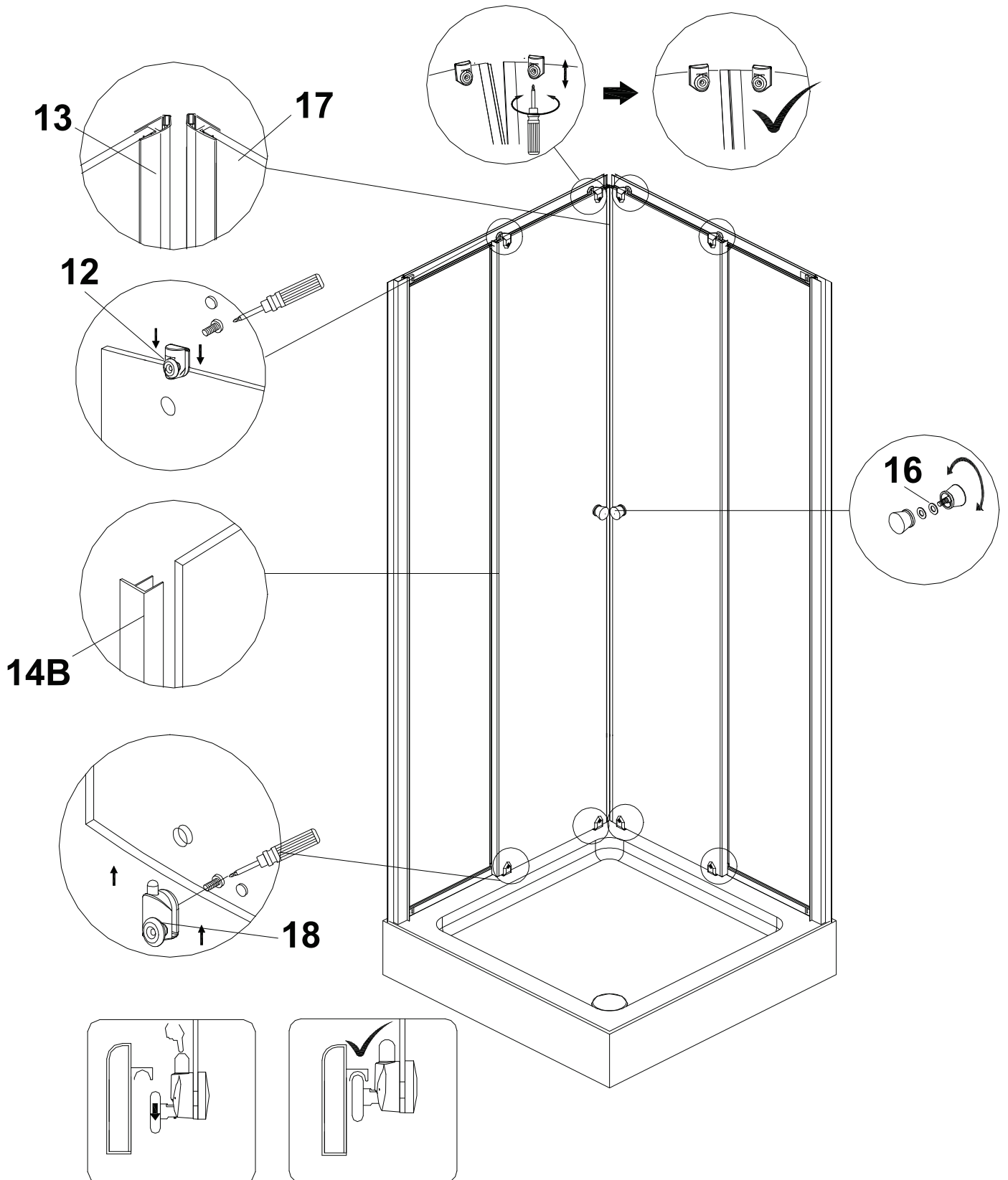
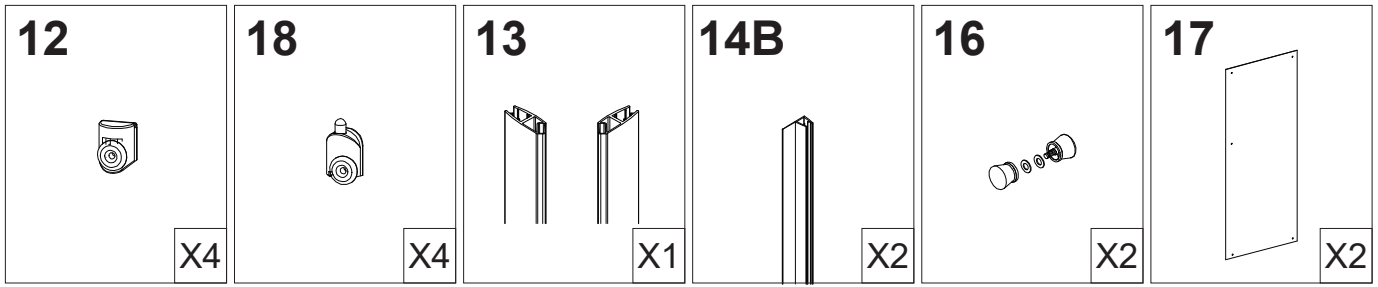

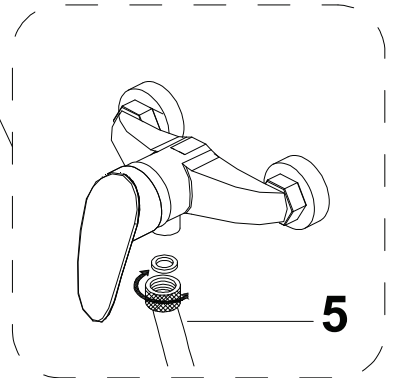
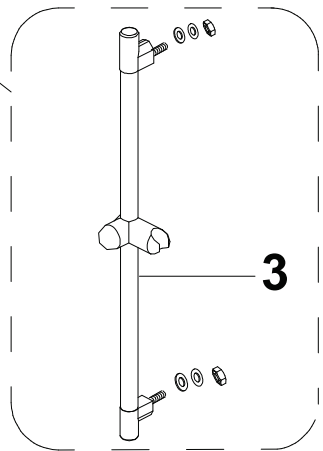
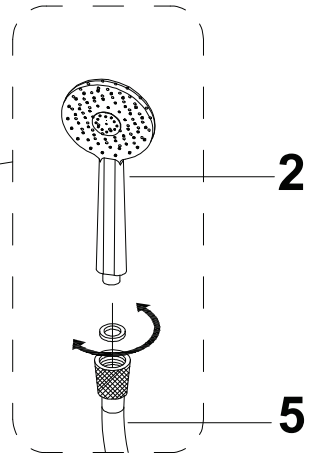
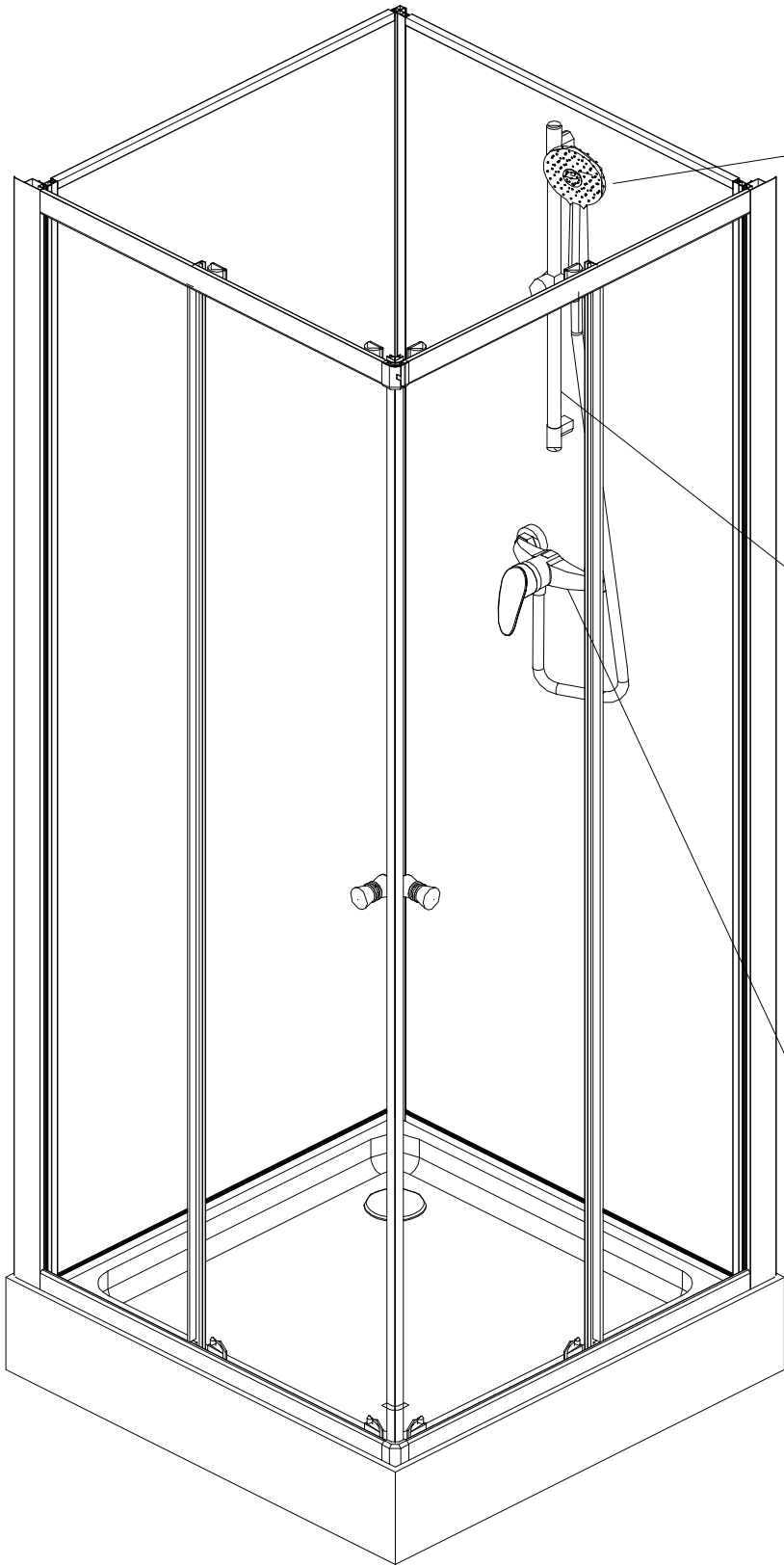
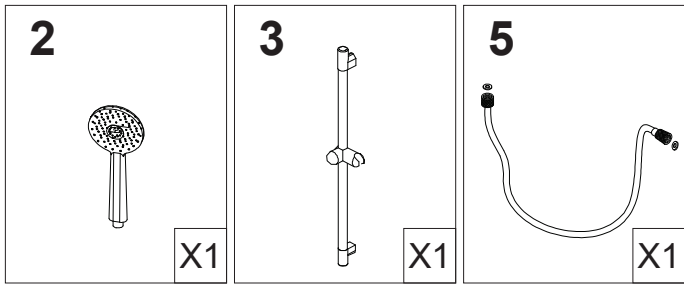



22

Fabriqué par KINDFORD LIMITED
Unit A and L, 15 Floor, MG Tower
133 Hoi Bun Road, Kwun Tong
Kowloon, HONGKONG

Paroi de douche

Réf : **1152327 (1248649)**

Déclaration des performances : N° KF2204SC115232700

EN 14428

Paroi de douche fabriquée en aluminium / verre

Utilisation prévue : hygiène personnelle

Aptitude au nettoyage : Conforme
Résistance à l'impact &
comportement à l'éclatement : Conforme
Durabilité : Conforme



22

Fabriqué par KINDFORD LIMITED
Unit A and L, 15 Floor, MG Tower
133 Hoi Bun Road, Kwun Tong
Kowloon, HONGKONG

Receveur de douche

Réf : **1152327 (1248649)**

Déclaration des performances : N° KF2204SC115232700

EN 14527

Receveur de douche fabriqué en ABS / Acrylique

Utilisation prévue : hygiène personnelle

Aptitude au nettoyage : Conforme
Durabilité : Conforme

Déclaration des performances

N° KF2204SC115232700

1. Code d'identification unique du produit type:

1152327 (1248649)

2. Numéro de type, de lot ou de série ou tout autre élément permettant l'identification du produit de construction, conformément à l'article 11, paragraphe 4:

Cabine de douche

3. Usage ou usages prévus du produit de construction, conformément à la spécification technique harmonisée applicable, comme prévu par le fabricant:

Usage prévu: Hygiène personnelle

4. Nom, raison sociale ou marque déposée et adresse de contact du fabricant:

KINDFORD LIMITED

**Unit A and L, 15 Floor, MG TOWER,
133 Hoi Bun Road, Kwun Tong, Kowloon, Hong Kong**

5. Système d'évaluation et de vérification de la constance des performances:

Système 4

6. Norme(s) harmonisée(s) applicable(s):

EN 14428:2015+A1 :2018 (Parois de douche: Prescriptions fonctionnelles et méthodes d'essai)

EN 14527:2016+A1 :2018 (Receveurs de douche à usage domestique)

7. Performances déclarées:

Caractéristiques essentielles	Performances	Spécifications techniques harmonisées
Aptitude au nettoyage	Conforme	EN 14428:2015 + A1 : 2018 Clauses 4.2
Résistance à l'impact / comportement à l'éclatement	Conforme	EN 14428:2015 + A1 : 2018 Clauses 4.3
Durabilité	Conforme	EN 14428:2015 + A1 : 2018 Clauses 4.4
Aptitude au nettoyage	Conforme	EN 14527:2016 + A1 : 2018 Clauses 6.2
Durabilité	Conforme	EN 14527:2016 + A1 : 2018 Clauses 6.3

8. Les performances du produit identifié aux points 1 et 2 sont conformes aux performances déclarées indiquées au point 7. La présente déclaration des performances est établie sous la seule responsabilité du fabricant identifié au point 4

Signé pour le fabricant et en son nom par:

Thierry Zeitoun











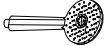
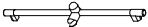

Managing Director

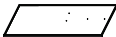
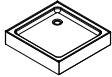



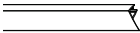
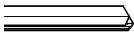

Fait à Hong Kong, le 26 Janvier 2022

For and on behalf of
KINDFORD LIMITED
通福有限公司

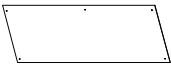
Authorized Signature(s)

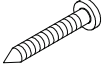
FICHE DE COMMANDE DE SERVICE APRÈS VENTE

Réf : 1152327 (1248649)

Numéro	Désignation	Schéma	Carton	**Cochez la case correspondante**	Quantité
1	panneau arrière		2/3	<input type="checkbox"/>	
2	douchette		3/3	<input type="checkbox"/>	
3	barre de douche		3/3	<input type="checkbox"/>	
4	mitigeur		3/3	<input type="checkbox"/>	
5	flexible		3/3	<input type="checkbox"/>	
6	vis ST3,9x12mm		3/3	<input type="checkbox"/>	
7	panneau de fonctions		2/3	<input type="checkbox"/>	
8	receveur de douche		3/3	<input type="checkbox"/>	
9A	rail de guidage supérieur		1/3	<input type="checkbox"/>	
9B	rail de guidage inférieur		1/3	<input type="checkbox"/>	
10	bloc de fixation		3/3	<input type="checkbox"/>	
11	connecteur		3/3	<input type="checkbox"/>	
12	roulette supérieure		3/3	<input type="checkbox"/>	
13	joint d'étanchéité magnétique		1/3	<input type="checkbox"/>	
14A	joint d'étanchéité paroi vitrée		1/3	<input type="checkbox"/>	
14B	joint d'étanchéité porte		1/3	<input type="checkbox"/>	
15	paroi vitrée fixe latérale		1/3	<input type="checkbox"/>	
16	poignée		1/3	<input type="checkbox"/>	

Numéro	Désignation	Schéma	Carton	**Cochez la case correspondante**	Quantité
17	porte coulissante		1/3	<input type="checkbox"/>	
18	roulette inférieure		3/3	<input type="checkbox"/>	
19	vis ST3,9x50mm		3/3	<input type="checkbox"/>	
20	bonde		3/3	<input type="checkbox"/>	
21	vis ST3,9x10mm		3/3	<input type="checkbox"/>	
22	joint d'étanchéité inférieur		3/3	<input type="checkbox"/>	
23	vis ST3,9x16mm		3/3	<input type="checkbox"/>	

CONDITIONS DE GARANTIE : Reportez-vous au livret de garantie Lapeyre, disponible aussi sur le site www.lapeyre.fr

LAPEYRE SA

Les miroirs, 18 avenue d'Alsace

92400 Courbevoie RCS Nanterre n°542 020 862

Service Clients : BP 149 93300 Aubervilliers Cedex