

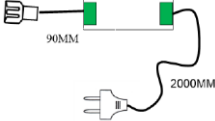



**NOTICE DE MONTAGE DU KIT 2 SPOTS-LED EN APPLIQUE ou  
A ENCASTRER POUR MEUBLES DE CUISINE**  
***INSTRUCTION FOR THE ASSEMBLY OF THE KIT 2 SPACER'SPOTLIGHT-  
LED FOR KITCHEN FURNITURE***

<b>A</b>  2000 mm <b>X 2</b>	<b>B</b>  90MM 2000MM <b>X 1</b>	
<b>C</b>  <b>X 4</b>	<b>D</b>  Ou <i>(or)</i> <b>X 2</b>	<b>E</b>  100MM <b>X 1</b> 

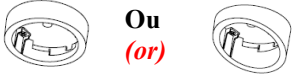

Ou  
*(or)*

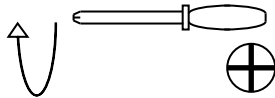
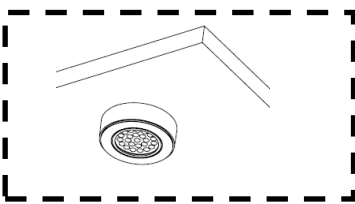
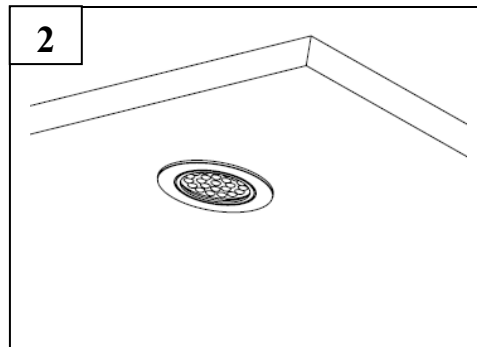
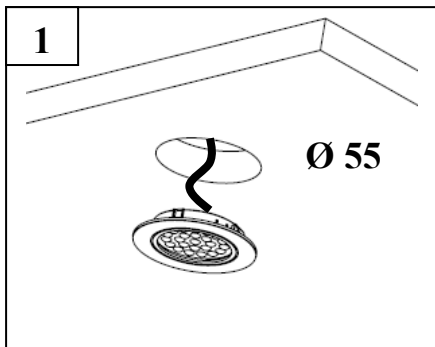
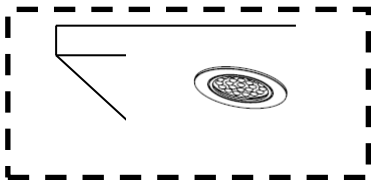
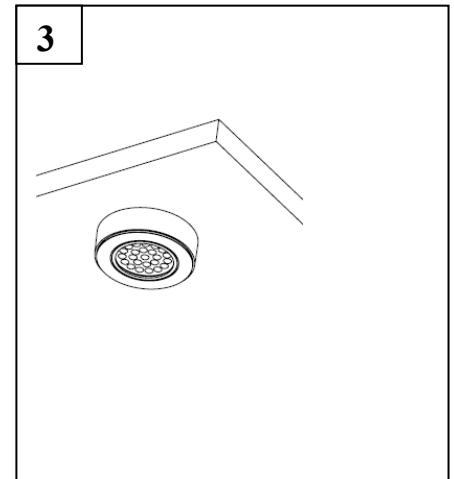
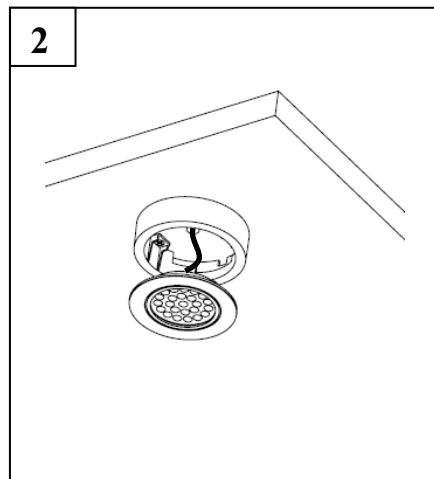
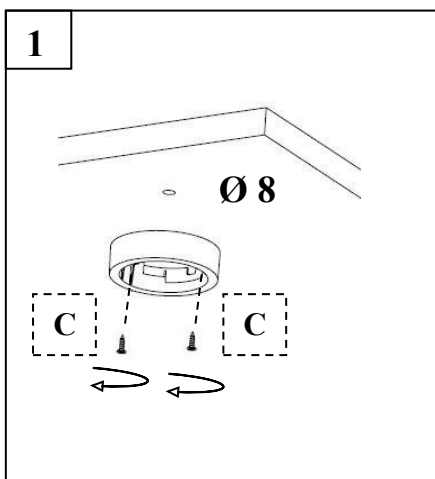
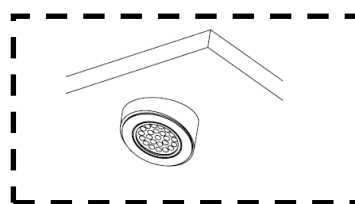

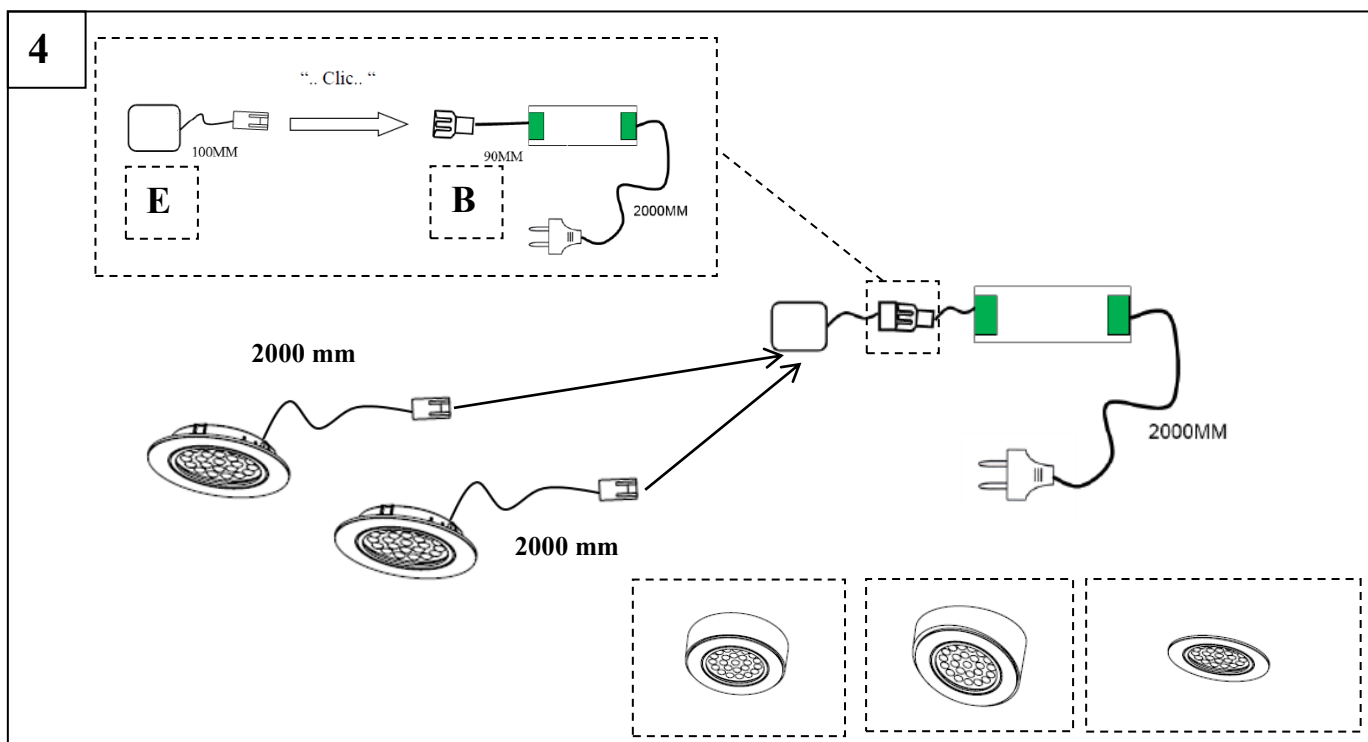

<b>Lumen (lm)</b>	2*140
<b>Watt ( W )</b>	2*2w
<b>Culot</b>	LED
<b>olt(v)</b>	230 Volts
<b>Kelvin</b>	4000 °K
<b>IRC</b>	80
<b>Led Group Risk</b>	0
<b>Kit Class</b>	A +



Appareil conforme aux directives européennes  
*Equipment conform at the european directives*



Appareil de classe II  
*CLASS II equipment*



Appareil pouvant s'installer sur des surfaces  
normalement inflammables  
*Equipment which can be install on normally flammable surfaces*



Traitement des déchets électriques et électroniques en fin de vie  
*Waste disposal for electric and electronic equipment in end of its life*

Les spots doivent être écartés au minimum de 20 cm entre eux et entre eux et le convertisseur.

Ce kit doit être installé dans les locaux secs.

Vérifier que la tension d'alimentation du réseau est bien de 230 V

Vérifier que la ligne d'alimentation est protégée par un fusible de 16A.

En cas de court circuit au secondaire, retirer la cause de ce court circuit et le transfo redémarrera automatiquement.

**The distance between the spots should be minimum 20cm and also between them and the transformer.**

**The kit must be installed in a dry room.**

**Check that the net tension is 230 V.**

**Check that the main will be protected by an 16 A's fuse.**

**In case of short circuit, once the problem will be solved, transformer will work again.**