

NOTICE D'INSTALLATION COLONNE FOKUS 2

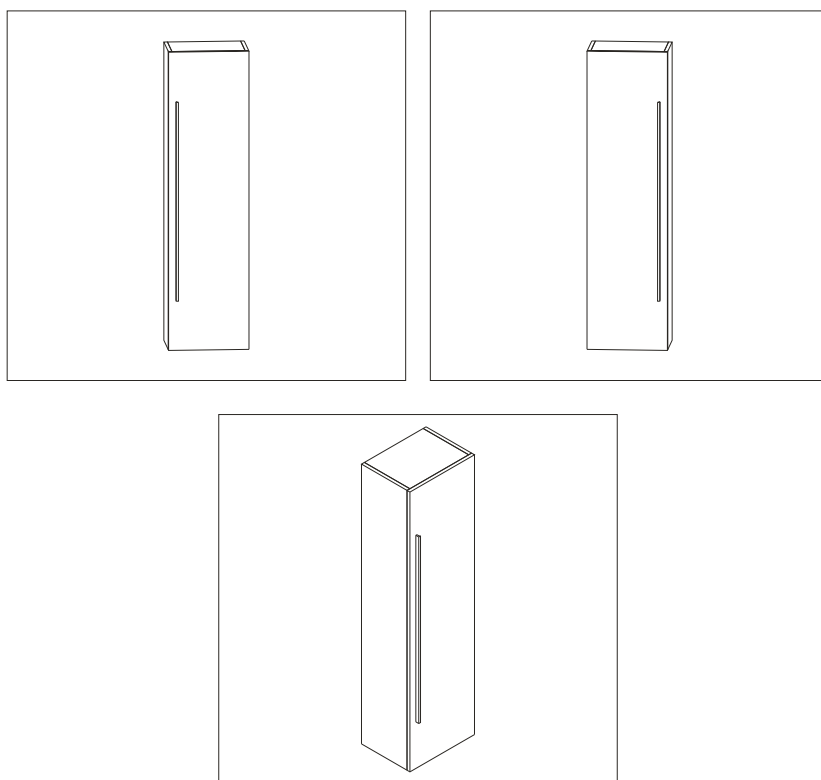

REMARQUES

Nous vous remercions de la confiance que vous nous avez témoigné en faisant l'acquisition de cet ensemble meuble de salle de bain.

Nous vous prions de bien vouloir inspecter ce produit avant l'installation car aucune réclamation ne pourra être prise en compte après l'installation.

Nous vous recommandons de bien suivre les instructions de montage.

Ce meuble doit être installé dans une salle de bain bien aérée. Il doit également être séparé de la baignoire ou de l'espace douche par un mur ou une paroi afin d'être hors de portée de jets d'eau, d'éclaboussures ou d'humidité excessive.

Merci de noter que les côtes mentionnées dans ce manuel sont données à titre indicatif. Merci de noter également que les croquis inclus dans les pages suivantes de ce manuel d'installation peuvent être légèrement différents du produit dont vous avez fait l'acquisition.

Pour préserver l'apparence de ce produit, nous vous recommandons de le nettoyer régulièrement, en utilisant un chiffon doux, propre et humide (eau douce). Attention, nous vous déconseillons fortement d'utiliser des agents nettoyants ou détergents abrasifs car ceux-ci risquent de détériorer la surface.

Conformément à notre politique de développement continu de nos produits, nous nous réservons le droit de modifier les spécifications de nos produits et de leurs composants.

DIMENSIONS(mm)

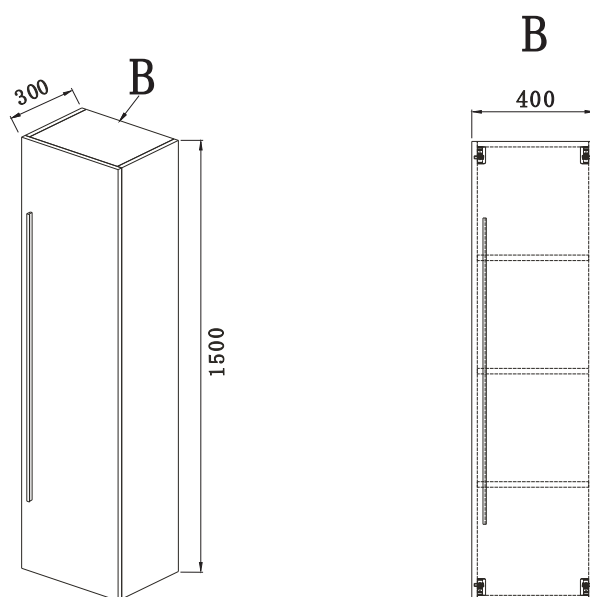

OUTILS NECESSAIRES (NON FOURNIS)

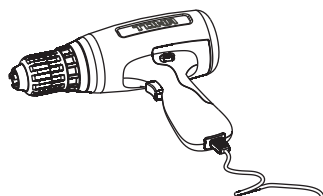

(ϕ 6)

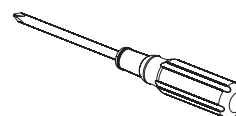
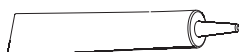
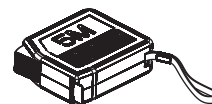

FIXATION MEUBLE SOUS-VASQUE



B
6PCS



C
6PCS

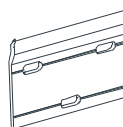

D
2PCS

Attention les murs sont de nature différente :

- Pleins, creux, brique, parpaings, carreaux de plâtre, plaques de plâtre

Pour bénéficier d'un montage en toute sécurité, il faut choisir sa quincaillerie (vis et chevilles) en fonction de la nature du mur. En cas de doute, il est fortement conseillé de demander l'avis d'un professionnel notamment avant la fixation du meuble à suspendre.

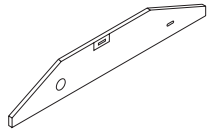

spirit level

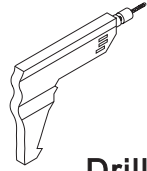

Drill

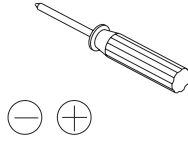

Screwdriver

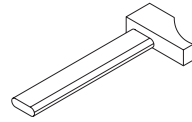

Hammer

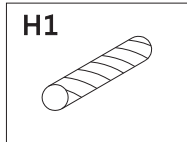
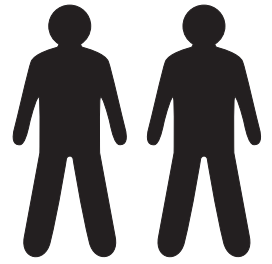

H1
8xØ8x30

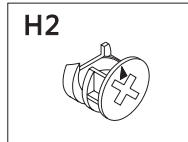

H2
29x

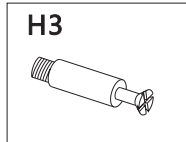

H3
29x

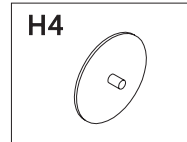

H4
29x

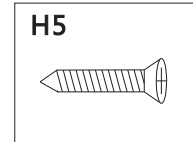

H5
19xM4x16

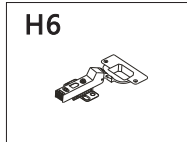

H6
3x

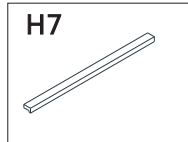

H7
1x

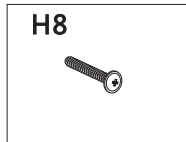

H8
3xM4x22

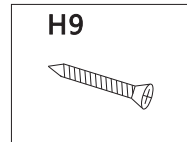



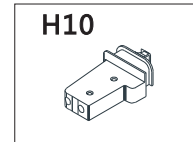



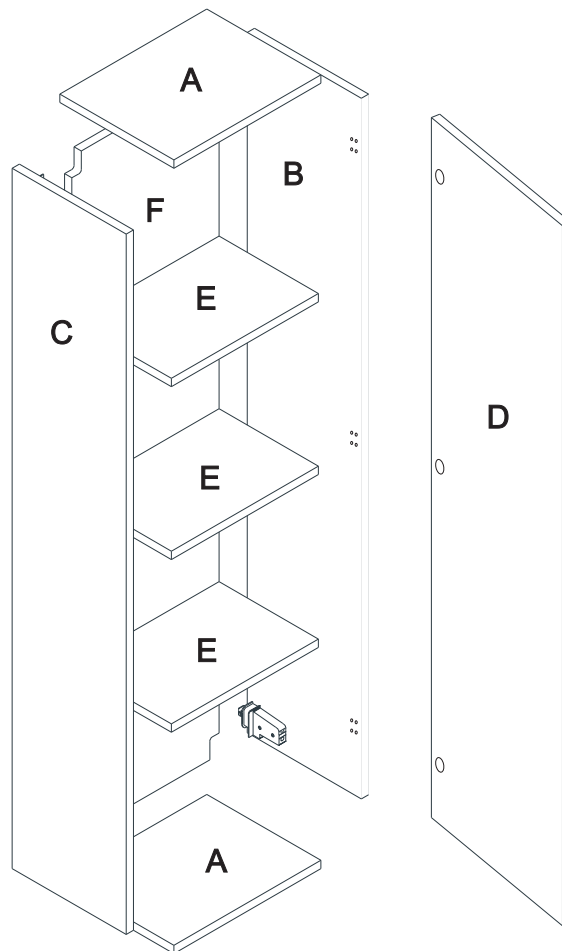

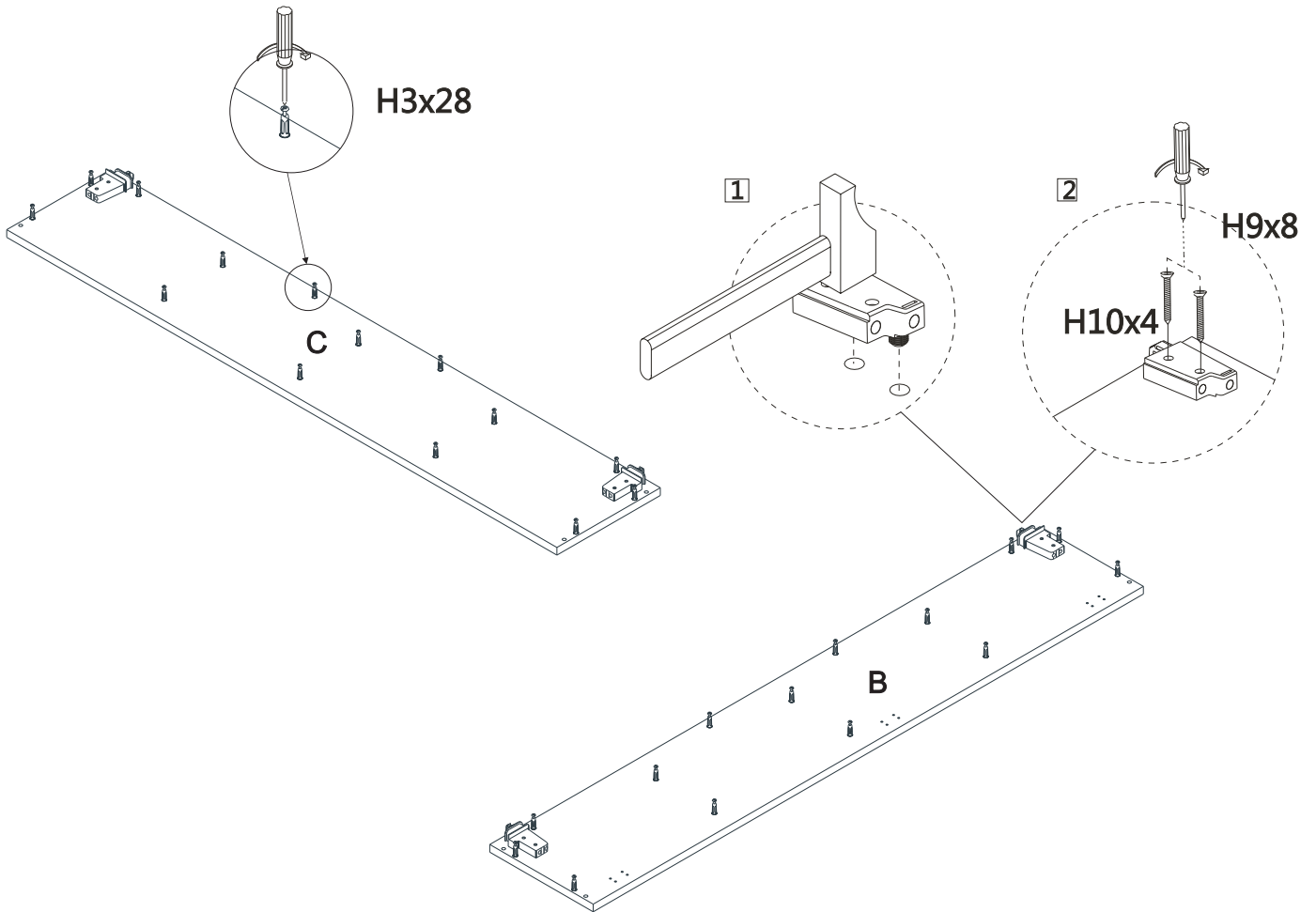
H9
8xM4x28



H10
4x



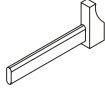





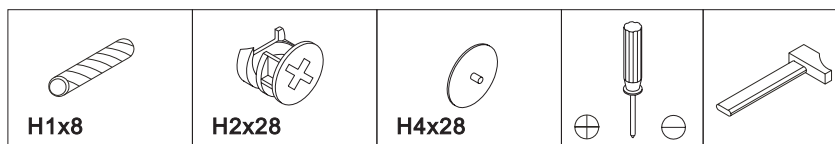
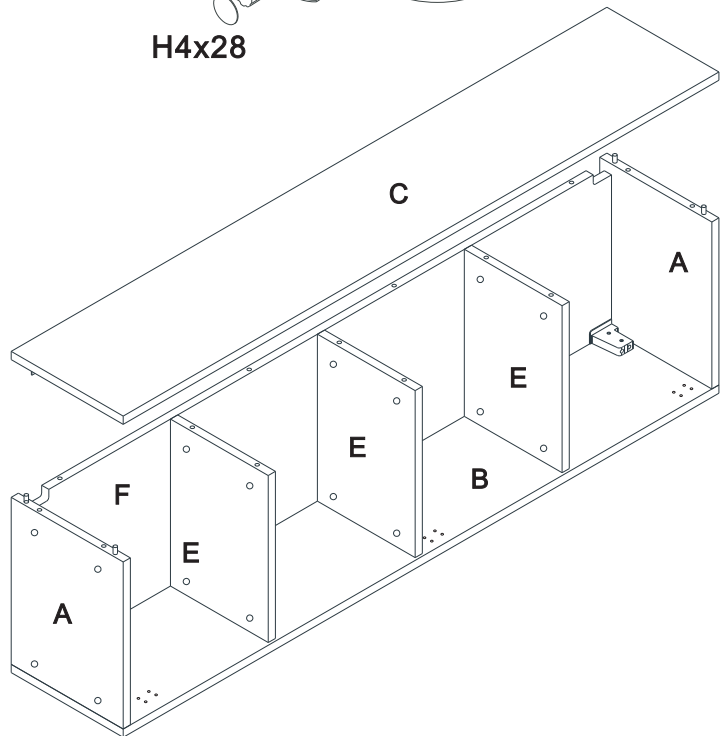
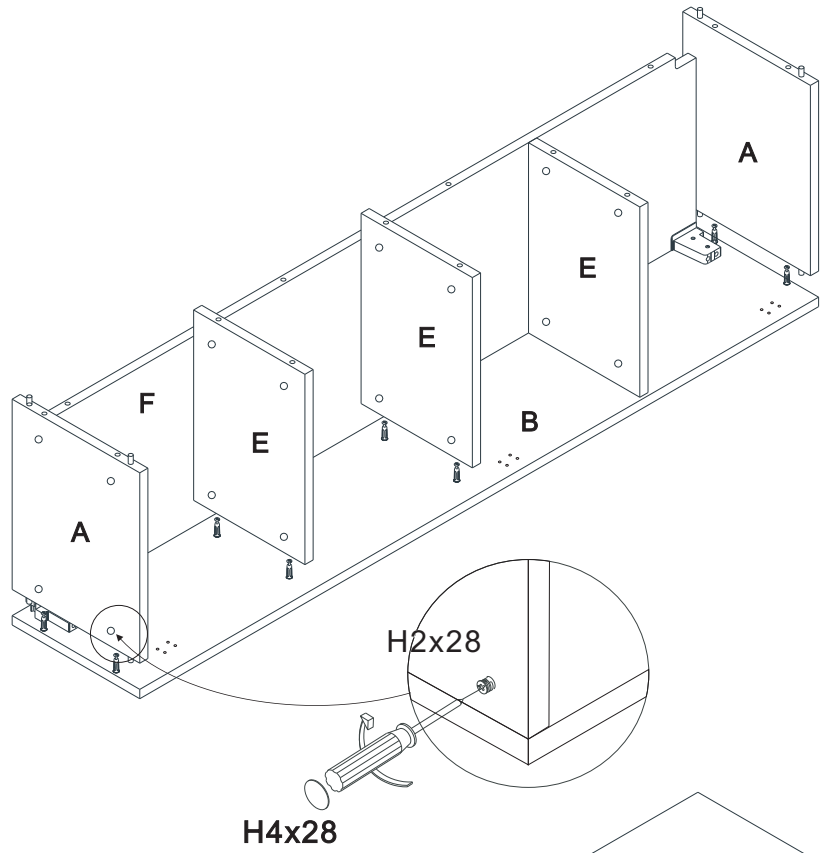
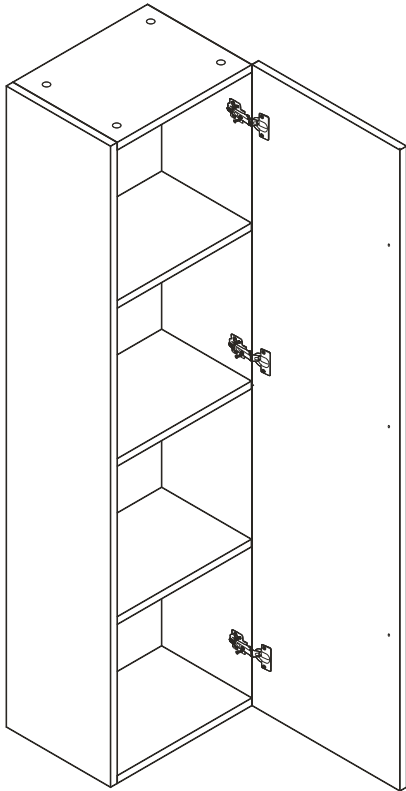

 H3x28	 M4x16 H5x18	 ⊕	 M4x28 H9x8	 H10x4		
--	---	--	--	--	---	---

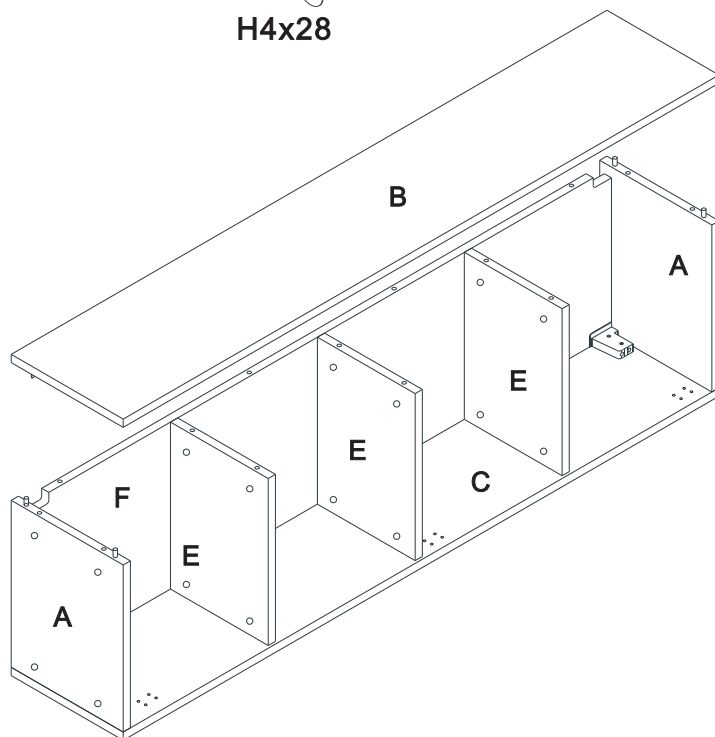
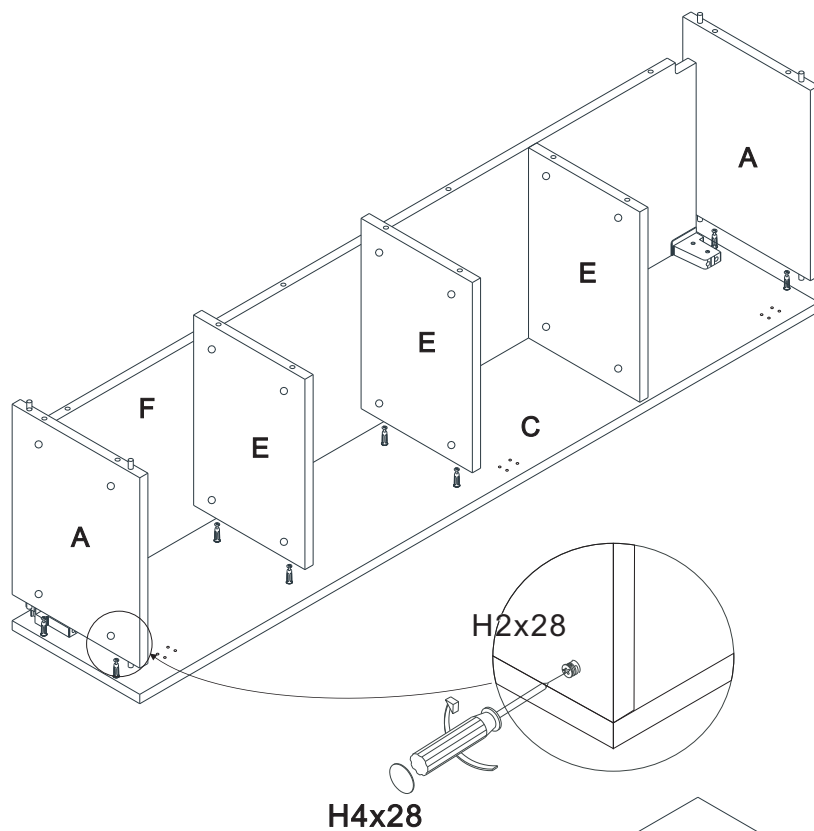
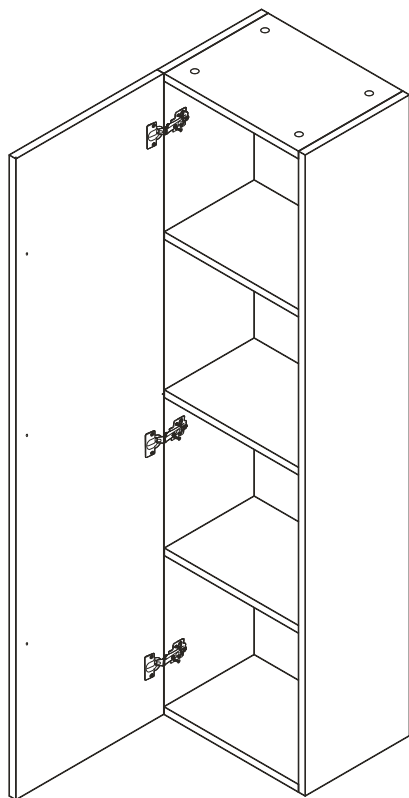
Pour un montage avec ouverture de la porte à droite



Pour un montage avec ouverture de la porte à gauche

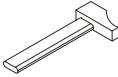

 H1x8	 H2x28	 H4x28	 	
--	---	---	---	---

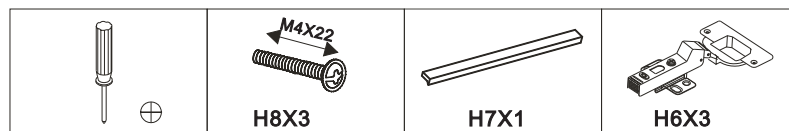
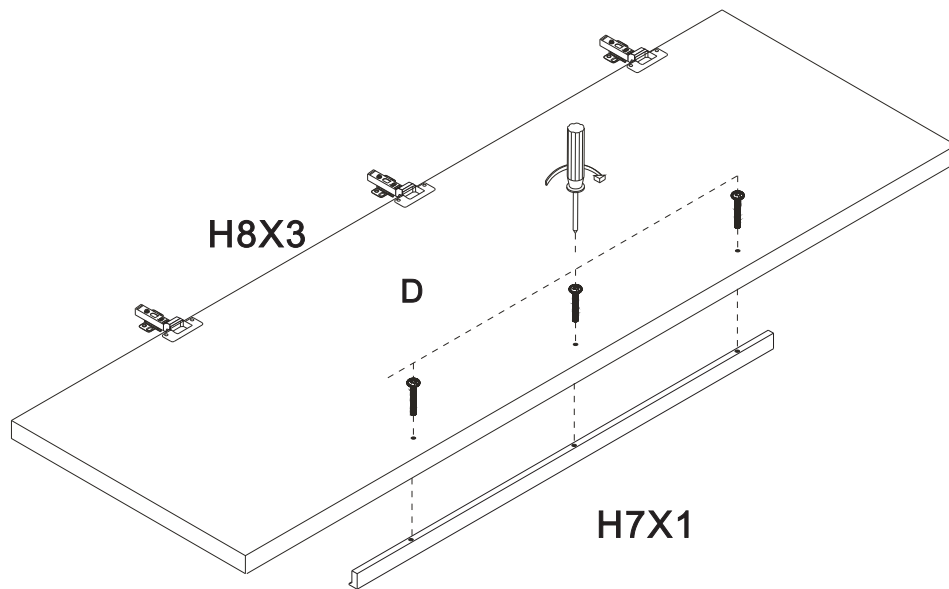
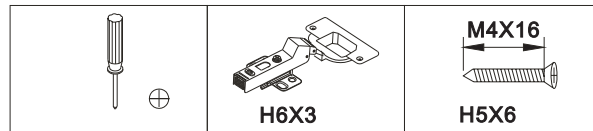
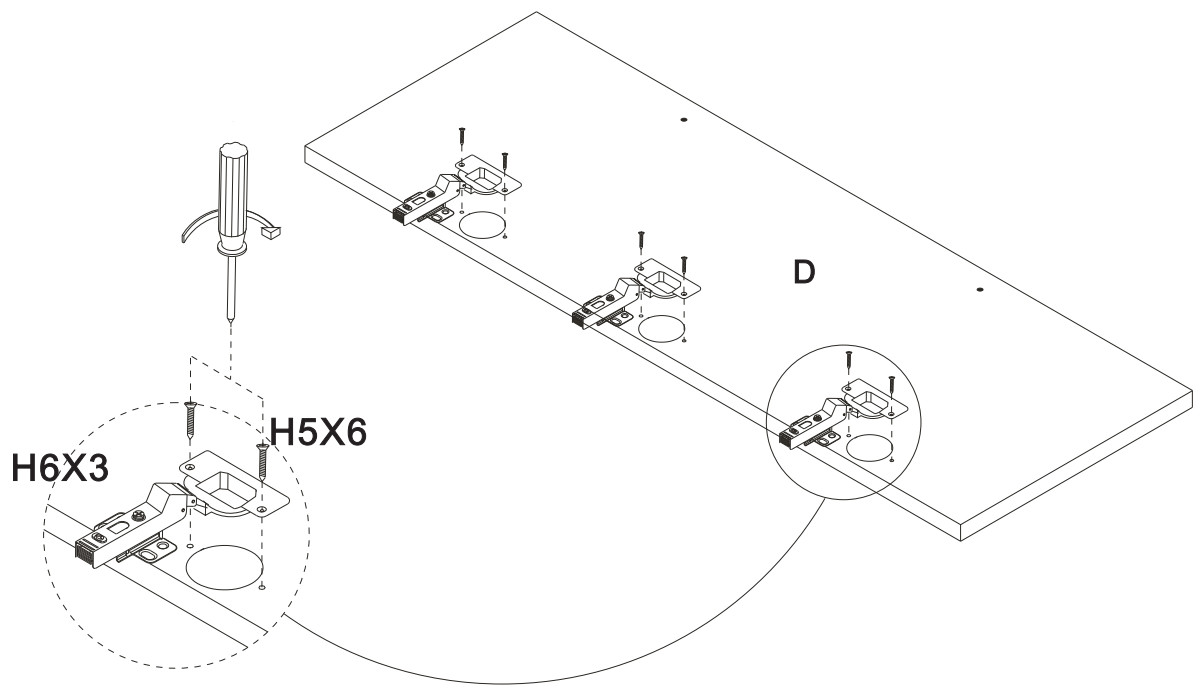

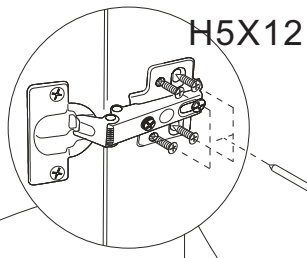

Ouverture de la porte à droite

Ouverture de la porte à gauche

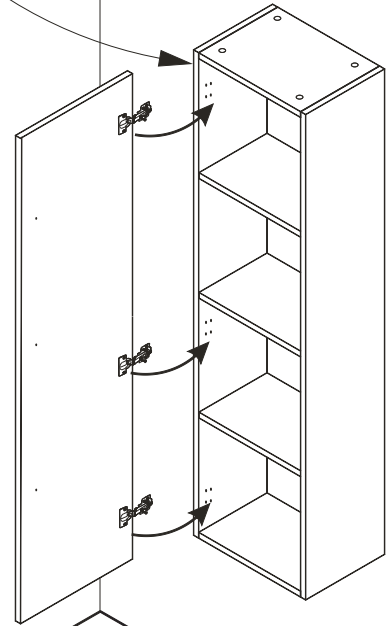
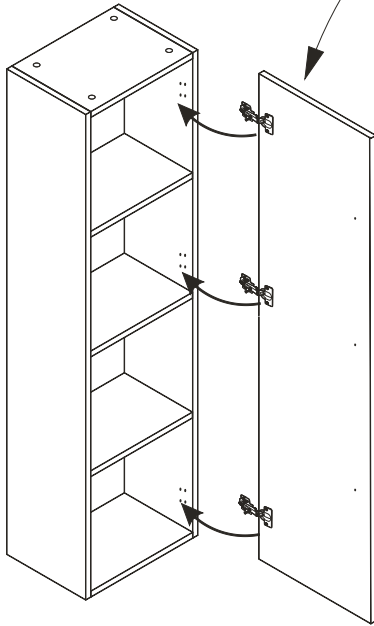

REGLAGES DES PORTES

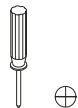
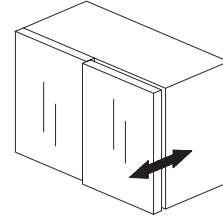
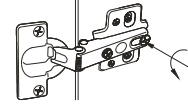
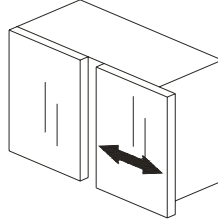
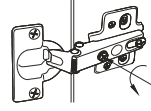
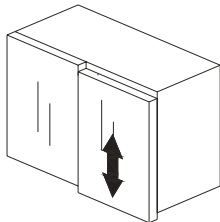
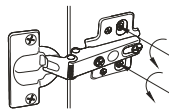

M4X16

H5X12

1-1

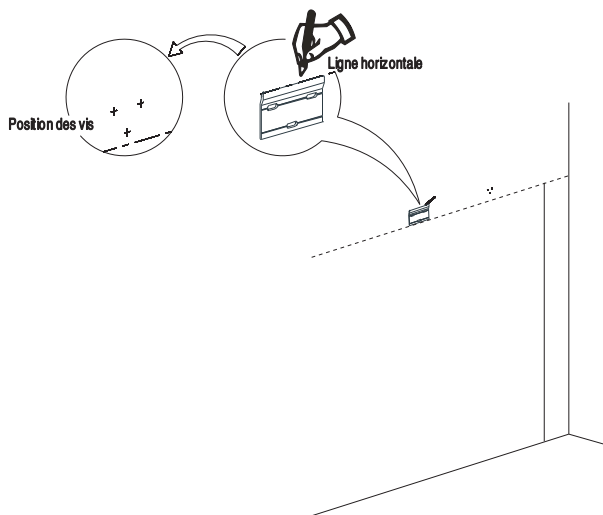

*Hauteur recommandée, attention de prendre en compte la hauteur des pieds du meuble si vous lui en rajoutez

1-2

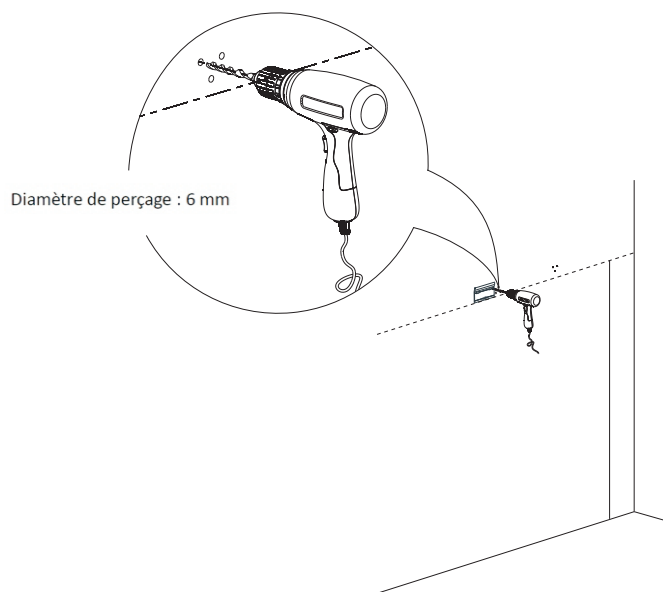

1-3

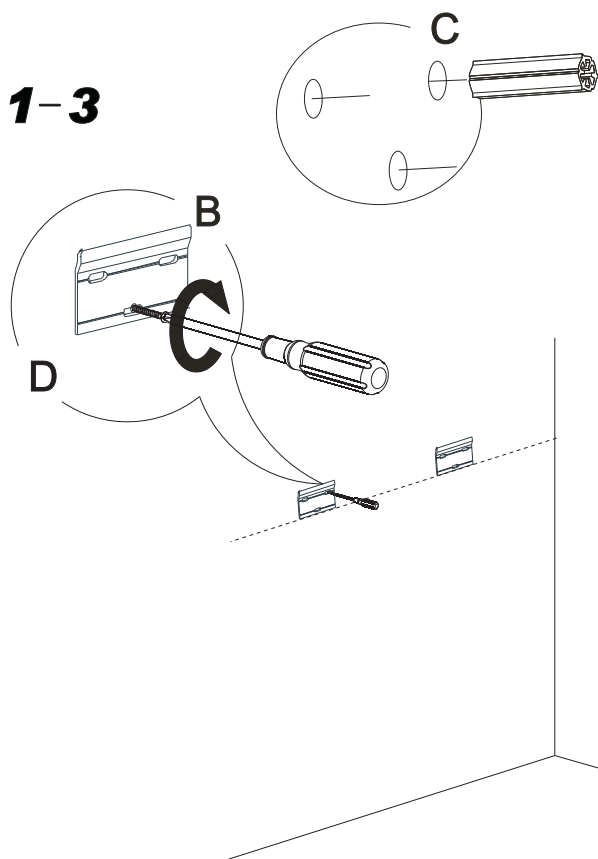

1-4

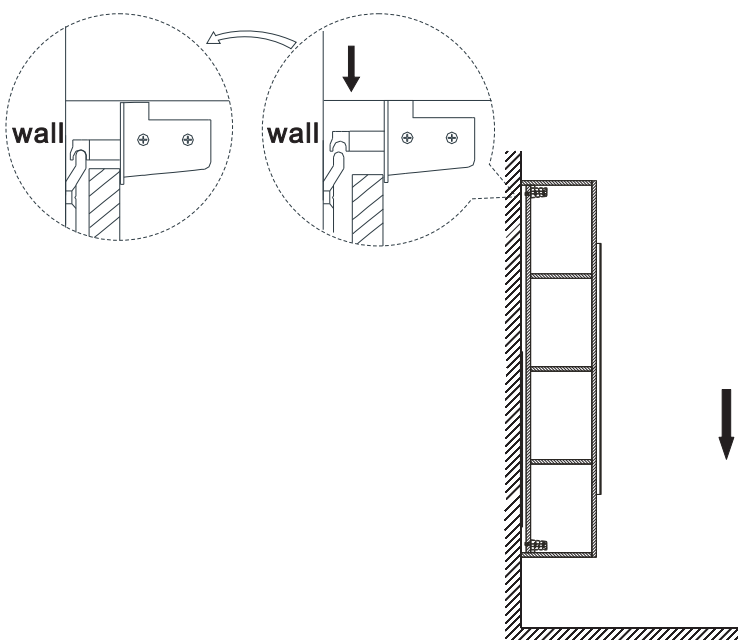

2 REGLAGE DU MEUBLE

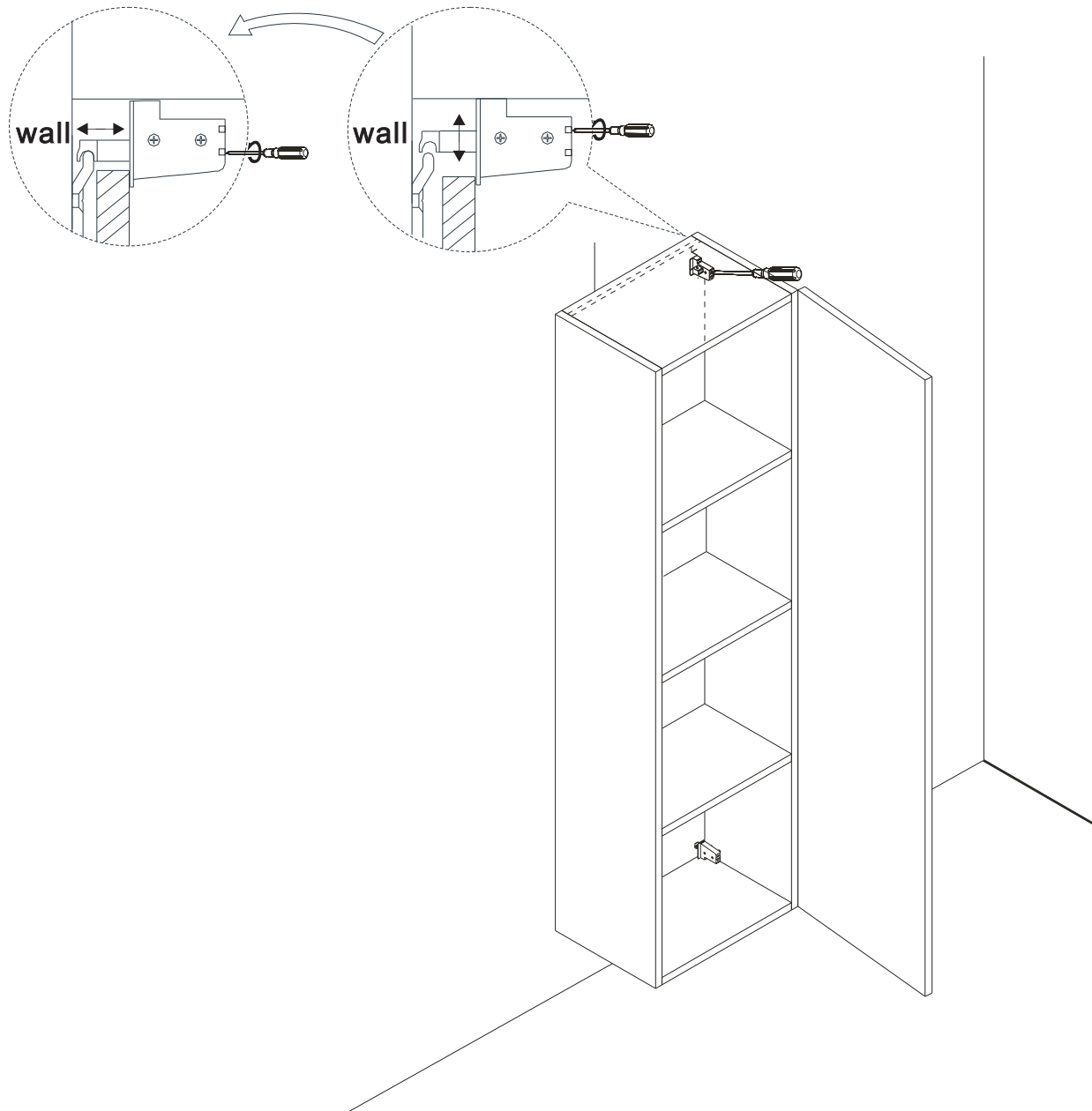

CONDITIONS DE GARANTIE : Reportez-vous au livret de garantie Lapeyre,
disponible aussi sur le site www.lapeyre.fr

LAPEYRE SA -Les Miroirs, 18 avenue d'Alsace-92400 Courbevoie-RCS Nanterre n° 542 020 862
Service Clients:BP 149-93300 Aubervilliers Cedex